

FIAMM

Industrial Batteries

Industrial Batteries



AGM

Installation & Operating Instructions
Technical Manual
Valve Regulated Lead Acid Batteries

❖ TABLE OF CONTENTS

❖ INTRODUCTION

❖ CONSTRUCTION FEATURES

- ◆ Plates
- ◆ Containers
- ◆ Separators
- ◆ Electrolyte
- ◆ Vent Plugs
- ◆ Terminal post

❖ OPERATING FEATURES

- ◆ Capacity
- ◆ Capacity in relation to discharge rate
- ◆ Capacity range of FIAMM Flooded Lead Acid Batteries
- ◆ Capacity in relation to the temperature
- ◆ Internal impedance and short circuit current
- ◆ Storage of filled and charged cells
- ◆ Storage of dry charged cells
- ◆ Service life
- ◆ Gassing
- ◆ Operation of batteries in parallel
- ◆ Electrolyte Specific Gravity - State of charge

❖ COMMISSIONING CHARGE / FIRST CHARGE

- ◆ Dry charge cells
- ◆ Filled and Charged Cells

❖ CHARGING

- ◆ Floating charge
- ◆ Boost charge (Recharge following a discharge)
- ◆ Equalize voltage

❖ BATTERY INSTALLATION

- ◆ Installation
- ◆ Battery room requirements

❖ SAFETY

- ◆ Protective Equipment
- ◆ Battery disposal

❖ MAINTENANCE

- ◆ Battery care
- ◆ Cleaning
- ◆ Voltage checks
- ◆ Specific gravity reading
- ◆ Cell Appearance
- ◆ Pilot Cell
- ◆ Periodic Inspections

❖ BATTERY TEST

❖ APPLICABLE STANDARDS

❖ **INTRODUCTION**

In a high technological environment it is extremely important to have a backup power source whenever possible. In fact mains power failure could cause severe losses and damages anytime.

FIAMM has been developing throughout years of research and experience several ranges of Absorbed Glass Batteries (AGM) to ensure the best reliability and quality.

❖ **CONSTRUCTION FEATURES**

The main construction features of FIAMM AGM batteries are shortly described in the below section.

◆ **Plates A**

Both positive and negative plates are of the flat pasted type. The active material is made of a paste of lead oxide, water, sulphuric acid and other materials needed to obtain the performances and stability required throughout the battery life. The grids are made of a high quality lead alloy with calcium and tin which assures good resistance against corrosion

◆ **Containers B**

Battery cases and lids are made of a type of ABS which complies with American Standards UL 94, class V-0 and with IEC 707, method FV0. This material is shock resistant and flame retardant. They are also designed to fully withstand the internal pressure variations during battery operation. This is further ensured by reinforced container walls and lids. Handles have been designed for some batteries into the lids to facilitate handling.

◆ **Separators C**

The separators are made of glass microfibre mats by a special process which results in a high porosity with very small pore diameters to ensure maximum oxygen diffusion while maintaining high plate utilisation and low internal resistance. The plates are completely wrapped by the separator and the electrolyte is completely absorbed in the separator and plates. By this method, the shedding of active material which during the battery life causes shorting with flooded battery construction is avoided.

◆ **Electrolyte**

The electrolyte is sulphuric acid of 1.3 sp. gr. at 20°C with same purity characteristics as other types of high quality lead acid batteries.

◆ **Valves D**

Each cell has a one way valve to permit the release of gases from the cell whenever the internal pressure exceeds the fixed safety value. The valve is rated at 0.15~0.30 atmospheres (15~30 Kpa).

◆ **Terminal posts E**

Suitable threaded post design ('male' or 'female' pole) with solid connectors are provided to ensure low ohmic losses. Post to lid seals are designed to prevent leakage over a wide range of internal pressures and conditions of thermal cycling. Intercell connections in the FIAMM multicell AGM battery design are electrically welded through the cell walls to minimise the internal impedance while maintaining complete separation of the individual cells.

Special plastic terminal caps are provided for transportation assuring a protection against short circuit during transportation. F

Cutaway drawing of FIAMM AGM cell

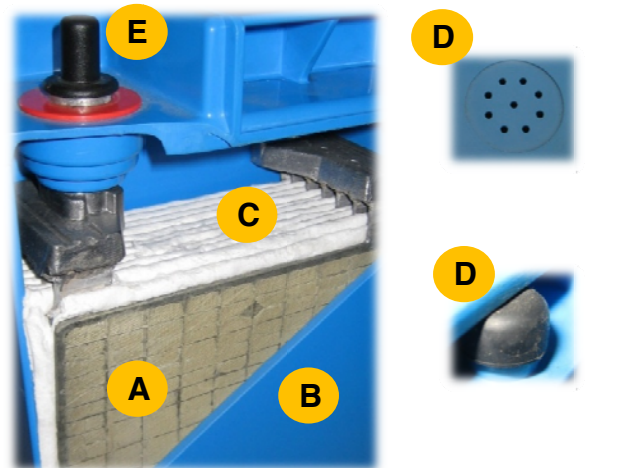

Female (Bolt) terminal

Male Terminal

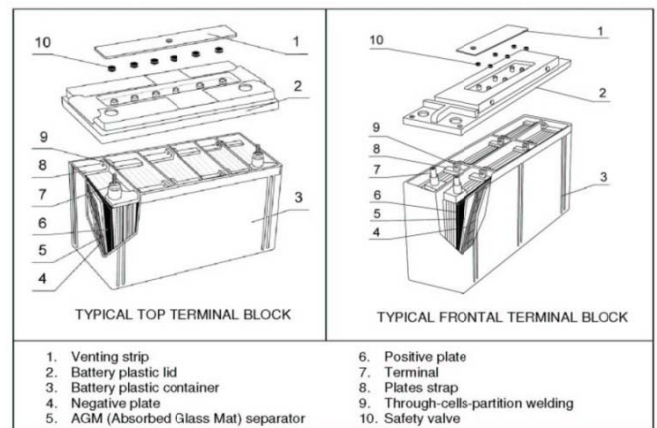

◆ **Connections**

Suitable solid connectors **1** are made of tin or lead plated copper; suitable insulated plastic covers **2** are made of ABS -V0

From 5 to 10 mm

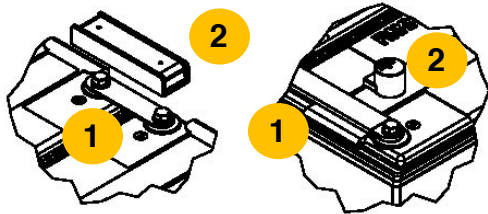
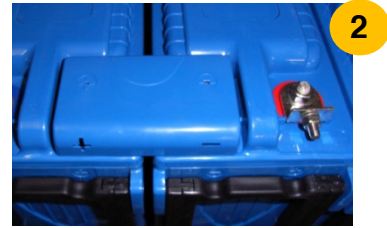
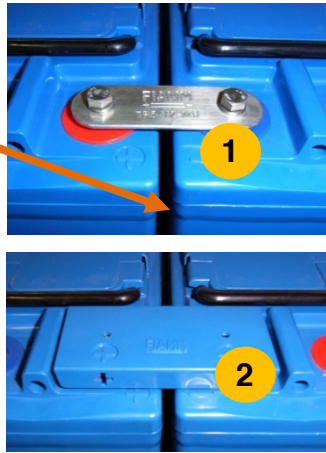

TOP TERMINAL CONNECTION is mainly used for FIAMM battery range SLA – FLB – SP as well

◆ **Front Terminal Connections**

Suitable solid connectors made of copper thin or lead plated and covers made of ABS are provided to make a proper installation between blocs. Designed for FIAMM front terminal range UMTB – FIT using a special “L” clamp

- 1** SOLID CONNECTOR
- 2** COVER
- 3** “L” CLAMP



◆ **Remote Venting System (RVS)**

Most of FIAMM AGM batteries are designed with an optional central degassing system on the top lid covering sheet. So if batteries need to be installed in a totally sealed cabinet, it is advisable to use the remote venting system available from the manufacturer to conduct any gas from the batteries to the outside of the cabinet itself.

- 4** RVS – front side used for FIT / UMTB range
- 5** RVS – top side used for SLA / FLB / SP / FIT / UMTB range

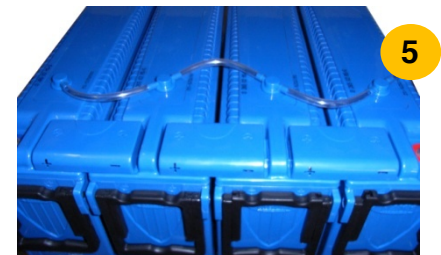

❖ OPERATING FEATURES

◆ Capacity

The battery capacity is rated in ampere hours (Ah) and is the quantity of electricity which it can supply during discharge. The capacity depends on the quantity of the active materials contained in the battery (thus on dimensions and weight) as well as the discharge rate, and temperature, and minimum voltage.

The nominal capacity of FIAMM batteries refers to the 10 hrs discharge rate (indicated with C_{10}) with constant current at 20°C to 1.80 volt per cell.

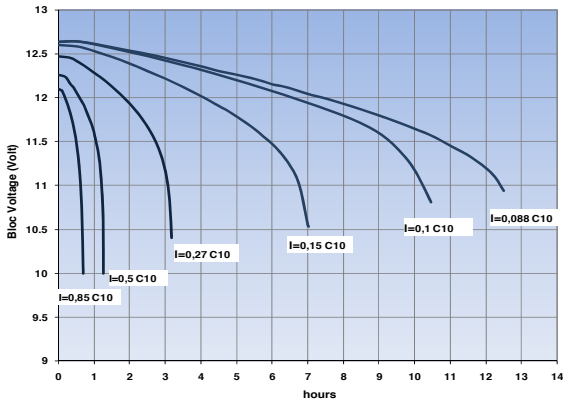

Fig. 1: Typical discharge curves for FIAMM AGM batteries (FIT range)

◆ Capacity in relation to discharge rate

The available capacity of all lead acid batteries depend on discharge rate (discharge current); this is due to internal electrochemical process and type of construction (i.e. type of positive plate).

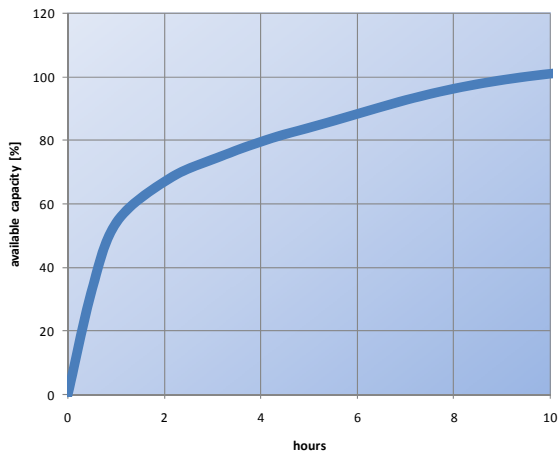

Fig. 2: Average available capacity versus discharge rates for FIAMM AGM batteries

◆ Capacity range of FIAMM AGM Lead Acid Batteries

FIAMM Battery range	Capacity range [Ah]
UMTB	from 60 to 160
FIT	from 40 to 180
SLA	from 25 to 2000
FLB	from 26 to 235
SP	from 26 to 235

◆ Capacity in relation to the temperature

The capacity available from a battery, at any particular discharge rate, varies with temperature. Batteries which have to operate at temperatures different from the nominal (20°C) need a higher or lower capacity as per the factor indicated in the following graph (required capacity has to be multiply by the correction factor stated in the graph).

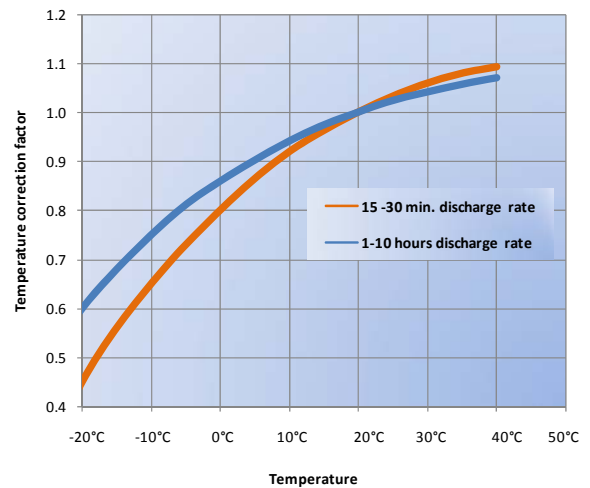

Fig. 3: Capacity Correction factor versus temperature for a 10 hours discharge rate for FIAMM Lead Acid AGM batteries

◆ Internal impedance and short circuit current

The internal impedance of a lead acid battery is a direct result of the type of internal construction, plate thickness, number of plates, separator material, electrolyte sp. gr., temperature and state of charge. The internal resistance and the short circuit current of FIAMM VRLA batteries at 100% state of charge and 20°C is indicated in the relative Product Sheet. These values are calculated in accordance with IEC 60896 part 21/22.

Different instruments are available to detect the internal resistance or impedance of lead acid batteries. These instruments use a different way to determinate these values. The values obtained from these instruments will be different to the values stated in FIAMM Product Sheet.

◆ **Service life**

According to the main international standards a battery is considered at the end of its service life whenever delivering less than 80% of its nominal capacity. The recommended operating temperature range is between 10°C to 30°C. FIAMM VRLA batteries can operate over a temperature range of -20 to +50°C and higher; operation at temperature higher than 20°C reduces life expectancy according to the graph in figure 4.

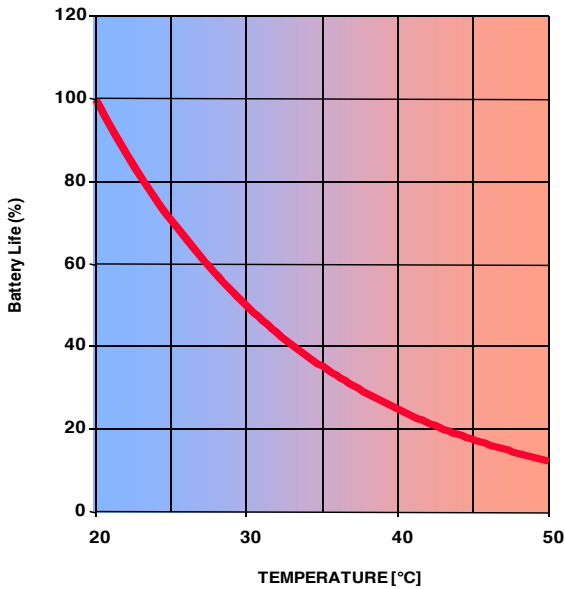

Fig. 4: Expected service life vs working temperature

◆ **Gassing**

All Lead Acid Batteries emits gases during the charge process. FIAMM VRLA batteries have a high recombination efficiency (>98%) and for cells operated at 20°C under normal operating conditions venting is virtually negligible. Laboratory test measurements show the following gassing rates:

- 2 ml/Ah/cell/month at a float voltage of 2.27 V/cell
- 10 ml/Ah/cell/month at a recharge voltage of 2.40 V/cell.

The quantity of gas given off in the air (it basically consists of 80-90% hydrogen) is very low and thus it is clear that FIAMM VRLA batteries can be installed in rooms containing electric equipment with no explosion danger or corrosion problems under normal conditions. In any case these rooms or cabinets must have a natural or forced ventilation and not be fully sealed. Please refer to “VENTILATION” for information on required air exchange.

◆ **Operation of batteries in parallel**

When the required capacity exceeds the capacity of a single string of batteries, it is possible to connect more strings in parallel paying attention to the following guidelines:

- in each string only cells or monoblocs of the same type, model and quantity should be used;
- a symmetrical layout of the batteries should be designed (i.e. length and type of connector) to minimize possible resistance variations;
- the quantity of strings in parallel should be reasonable in terms of layout and application. Usually 4 strings could be connected in parallel. However, depending on strings voltage and cables length, a higher number of strings could be safely connected to reach required total capacity.

◆ **Open circuit voltage - State of charge**

The measurement of the open circuit voltage (battery has to be disconnect from charger system for at least 24 hours) provides an approximate indication of the state of charge of the cells.

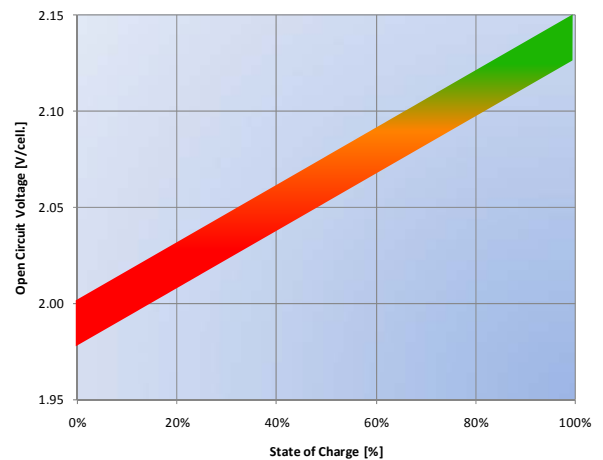

Fig. 5: Approximate state of Charge versus Open circuit cell voltage

❖ RECHARGING

In order to ensure the best protection against power failures in any moment, it is necessary that batteries are kept in the following conditions:

- in float charging throughout all their standby period;
- fully recharged soon after a discharge,
- completely recharged after a discharge. Recharge as soon as possible to ensure maximum protection against subsequent power outages. Early recharge also ensures the maximum battery life.

◆ Floating charge

Floating battery systems are those where the charger, the battery and the load are connected in parallel.

The "float" setting will maintain the battery in a fully charged state with minimal water consumption.

The voltage recommended for float charge is 2.27 V at 20°C. The recommended float voltages to maximise the battery life over the range of temperatures between -20 and +60°C are shown in the figure 6.

The normal float current observed in fully charged FIAMM front terminal batteries at 2.27 VPC and a temperature of 20°C is approximately 0.3 mA/Ah. Because of the nature of recombination phenomena, the float current observed in the case of the FIAMM front terminal batteries is normally higher than that of vented batteries and is not an indication of the state of charge of batteries

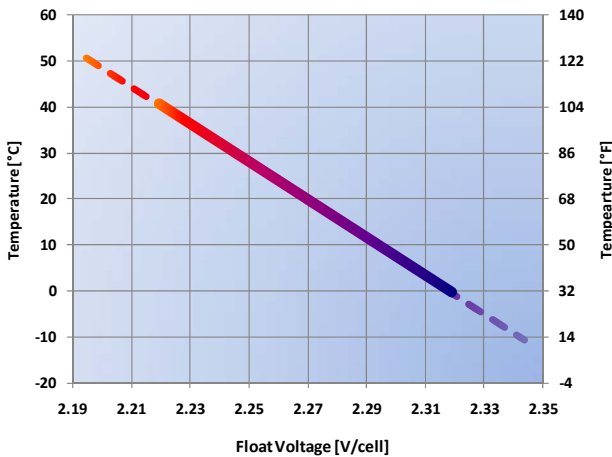

Fig. 6 Recommended Float Voltage at different temperatures

◆ Boost charge (Recharge following a discharge)

Boost charge has to be used to recharge a battery after a discharge; it will restore the battery to a fully charged state within a relatively short period of time. Use a constant voltage 2.4 V/cell at 20°C with a maximum current of 0.25 C10. However this recharge should be

limited to no more than once per month to ensure the maximum service life of the battery.

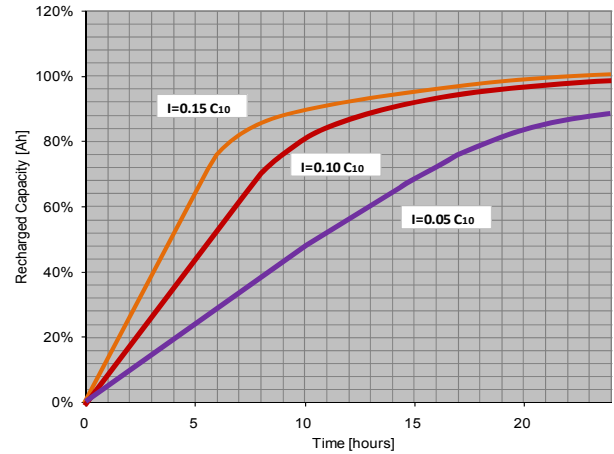

Fig. 7 Recharge curves at 2.4 volt per cell with different limit of current

❖ BATTERY INSTALLATION

All necessary precaution must be taken when working with lead acid batteries as per electrical risk, explosives gasses, heavy components, corrosive liquids. Use insulated tools and wear protective equipment.

◆ Installation

FIAMM front terminal valve regulated recombination batteries can be fitted on stands or into cabinets. FIAMM offers a wide selection of stands, from one tier/one row to six tiers/three rows, to suit most applications. Cabinets are available with or without circuit breaker and its relevant compartment.

1. Avoid any impact or shock which could cause breaking or micro fractures to container. Do not lift cells by its terminals.
2. Make sure that all cell jars and covers are thoroughly clean and dry.
3. Synthetic cleaning cloths must not be used. Clean lids and containers only with antistatic cotton cloths soaked in a solution of mild soap and completely "wrung" out.
4. Should the terminal posts have a white film on them, lightly abrade their contact surfaces, using a Scotchbrite pad or fine grit abrasive paper, to remove any surface oxidation.
5. Do not lift cells by terminals; do not use terminals as point of lifting during handling/installation process.
6. Place the single units at their correct position according to the electrical layout.
7. In order to allow heat dissipation a minimum distance of 5-10mm between cells/blocs is recommended; this is normal using FIAMM standard connectors; for special requirements please contact FIAMM .
8. Care must be taken to avoid short circuiting the cells with any of the battery hardware.
9. Start with the lowest shelf to ensure stability. Carefully preserve the sequence: positive, negative, positive, negative throughout the whole battery. Flexible cable connectors for connecting from one shelf to the one below, will be applied once that all the blocs have been connected (we would suggest to connect such inter-shelf or inter-row cable connectors at the final User's premises only).
10. To ensure a good electrical contact between the bottom of each terminal and the connecting strap and, at the same time, to ensure that the threaded terminals are not damaged by excessive torque, use a torque spanner set on the value of:

RANGE	TYPE	VALUE Nm	VALUE Lbs
SLA-UMTB-FIT-FLB	M8 Female	10÷12	88÷106
SLA	M10 Female	20÷25	175÷220
FLB	M6 Female	7÷9	62÷80
SLA-UMTB	M8 Male	7÷8	65÷70
FIT-UMTB	M6 Male	5÷7	44÷62

11. Insulate all the connectors by means of the plastic covers being supplied with the battery accessories.
12. Affix the cell number stickers to the cell jars making sure that the surfaces are dry and clean. It is usual to number the cells beginning with #1 at the positive end of the battery, numbering consecutively in the same order as the cells are connected electrically, through to the negative end of the battery.
13. Check the total battery voltage which should comply with the total number of cell connected in series.
14. The cells are usually designed to be installed in vertical position, the horizontal position could in some cases stress the cells. Here below the correct cell arrangements for large capacity AGM cells.

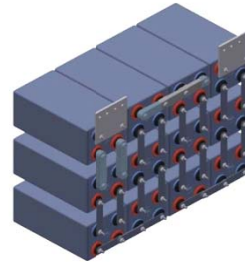

Example of installation and cell arrangement (position of + / - poles) of AGM batteries with capacity equal or higher than 800Ah

◆ Batteries installed into cabinet

For safety reasons, we would not recommend to pre-assemble the blocs into the cabinets before shipment to the final Customer. However, if this is normal practice for some system makers, we would strongly recommend to pay special attention to protect the battery system from mechanical stress and vibrations occurring during transport. For this purpose, we would require to properly fasten all the blocs to the relevant cabinet shelves by means of plastic band and/or other adequate methods. Furthermore, the cabinet should be protected, in the outside, with shock-absorbing packaging material, in order to prevent any transmission of vibrations to the internal components such as the battery blocs. Special precautions must be taken to avoid accidental short circuits (do not connect all the batteries, divide the battery circuit low voltage parts).

For any further information please refer to EN50272 Standard or contact FIAMM at: info.standby@fiamm.com

◆ Ripple

Residual Ac ripple is usually present in the output voltage of chargers; amplitude and frequency depends on charger design and it can affect negatively the battery life. Ripple could increase water loss, battery temperature and accelerate corrosion with a result to reduce the battery life. It is recommended therefore, that voltage regulation across the system including the load, but without the battery connected, under steady state conditions, shall be better than ± 1 through 5% to 100% load. Transient and other ripple type excursions can be accommodated provided that, with the battery disconnected but the load connected, the system peak to peak voltage, including the regulation limits, falls within 2.5% of the recommended float voltage of the battery. Under no circumstances should the current flowing through the

battery when it is operating under float conditions, reverse into the discharge mode.

◆ Battery room requirements

- The battery room should be dry, well ventilated and have its temperature as moderate as the climate will allow, preferably between 10°C and 30°C.
- **DO NOT permit smoking or the use of open flames in the battery room.**
- Adequate ventilation to change the air in the battery room is essential to prevent an accumulation of the gases given off during charge (for further information please refer to "VENTILATION" paragraph).
- The battery will give the best results and life when working in a room temperature of 20°C, but will function satisfactorily when operating in temperatures between -20°C and +60°C. High temperatures increase the performance, but decrease the life of the cells; low temperatures reduce the performance.
- Do not allow direct sunlight to fall on any part of the battery.
- If a rack is not supplied by FIAMM, suitable racks should be provided to support the cells. These should be arranged to provide easy access to each cell for inspection, topping up and general maintenance. Suitable racks may be made of wood or metal with a coating of acid resistant paint. If metal racks are used, they must be fitted with rubber or plastic insulators to prevent the cells coming into contact with the metal.
- To facilitate proper battery operation, maintenance, and care, post a battery data card/ instruction table in a conspicuous place near the battery to provide the attendant with service information and data.

❖ SAFETY

It is recommended that full precautions be taken at all times when working on batteries. The safety standards of the country of installation must be risk, explosives gasses, heavy components,

◆ Protective Equipment

Make sure that the following equipment is available to personnel working with batteries:

- Instructions manual.
- Tools with insulated handles.
- Fire extinguisher.
- PPE (Personal Protective Equipment) must be worn (glasses, gloves, aprons etc ...). To avoid static electricity when handling batteries, material of clothing, safety boots and gloves are required to have a surface resistance $0 \leq 10^8 \Omega$, and an insulation resistance $\geq 10^5 \Omega$
- First aid equipment must be available.

◆ Safety Precautions

Observe the following precautions at all times:

- Batteries are no more dangerous than any other equipment when handled correctly
- Do not allow metal objects to rest on the battery or fall across the terminals (even when disconnected, a battery remain charged!).
- Never wear rings or metal wrist bands when working on batteries.
- Do not smoke or permit open flames near batteries or do anything to cause sparks.
- Do not try to remove the battery cap to add water or acid into the cell(s).
- Never lift or pull up the battery at the terminals.
- Air exchange must be provided to prevent the formation of explosive hydrogen concentration.
- For further information please refer to EN 50272-2 Safety requirements for secondary batteries and battery installations Part 2: Stationary batteries.

◆ Battery Disposal

Lead acid batteries must be disposed according to the country law. It is strongly recommended to send batteries for recycling to a lead smelter. Please refer to the local Standards for any further information, these batteries need to be collected separately for wast disposal. As of the 31st of December 1994, all Valve Regulated Lead Acid (VRLA) battery has to have the following symbols present in conformance to EG-guideline 93/86/EWG



Pb

❖ SELECTION OF APPLICABLE STANDARDS

FIAMM Valve Regulated Lead Acid Batteries comply with:

- IEC 60896 –Part 21 Stationary lead-acid battery Valve Regulated Type – Methods of tests;
- IEC 60896 –Part 22 S Stationary lead-acid battery Valve Regulated Type - Requirements
- EN 50272-2 Safety requirements for secondary batteries and battery installations Part 2: Stationary batteries.
- BS 6290-4 Lead-acid stationary cells and batteries. Specification for classifying valve regulated types.
- BS 6290-1 Lead-acid stationary cells and batteries. Specification for general requirements

❖ MAINTENANCE

◆ Battery care

**GASES GIVEN OFF BY BATTERIES ON CHARGE ARE EXPLOSIVE!
DO NOT SMOKE OR PERMIT OPEN FLAMES OR DO ANYTHING TO CAUSE SPARKS NEAR BATTERIES.**

1. Keep the battery and surroundings clean and dry.
2. Make sure that bolted connections are properly tightened (see table in INSTALLATION paragraph).
3. Usually it is not necessary to apply grease on the bolts and connectors, in any case "No-oxide" grease increase the protection against corrosion.
4. Should any corrosion of the connections occur because of spilled acid, etc., carefully remove corrosion materials, thoroughly clean and neutralize with diluted ammonia or baking soda.
5. Keep the battery at the recommended charge voltage (see CHARGING section).
6. The room in which the battery is installed should be well ventilated and its temperature as close as possible to 20°C.
7. Do not try to open the cover valve.

◆ Cleaning

When necessary, batteries could be cleaned using a soft dry antistatic cloth or water-moistened soft antistatic cloth paying attention not to cause any ground faults.

No detergent nor solvent-based cleaning agents nor abrasive cleaners should be used as they may cause a permanent damage to the battery plastic container and lid.

◆ Voltage checks

All voltage measurements should be made when the whole battery has stabilized on floating, at least 7 days after battery installation or after a discharge/ charge cycle. To facilitate voltage reading in the correspondence of each block terminal protection covers are designed with a safe and proper hole. Measure and record individual block voltages on float once a year. It is normal to have a spread of block voltages at 20°C up to $2.27^{+0.2}/_{-0.1}$ V ($13.62^{+0.54}/_{-0.29}$ for a 12 volt battery) particularly in the first year of operation. No corrective action is required in this case. Maintaining a correct battery charging voltage is extremely important for the reliability and life of the battery. So it is advisable to carry out a periodical checking of the overall float voltage to verify any possible defect of charger or connections.

◆ Cell Appearance

Any cells showing corrosion, container bulging, high temperature than the other cells, should be regarded as suspect. Such cells should be carefully examined and, expert advice should be obtained immediately from FIAMM.

◆ Pilot Cell

For regular monitoring of the battery condition, select one or more cells of the battery as a "pilot" cell(s); for batteries comprising more than 60 cells, select one pilot cell for every 60 cells.

◆ Periodic Inspections

Written records must be kept of battery maintenance, so that long-term changes in battery condition may be monitored. The following inspection procedures are recommended:

EVERY SIX MONTHS:

- Visual inspection on cells/racks (appearance, cracks or corrosion signs, electrolyte leakage..),
- check and record the overall float voltage at the battery terminals (not at the charger!),
- measure and record the pilot cell(s) voltage,
- measure and record the pilot cell(s) temperature,
- room ventilation.

YEARLY:

- all the controls indicated at six months,
- check and record the voltage of all cells,
- measure and record the pilot cell(s) temperature,
- make sure all connection are torque according to connection torque table; in case of frequent high discharge current please consider to check,
- clean the cells.

❖ BATTERY TEST

Test must be conducted in accordance with EN 60896-21/22.

Before any discharging test batteries have to be properly prepared with a boost charge (2.4 volt per cell for 24 hours at 20°C) to ensure they are in a fully charge condition. In order to take temperature readings of a battery, one pilot cell or block shall be chosen. The surface temperature of the container wall centre of each pilot cell or block shall be measured immediately prior to the discharge test. The individual readings shall be between 15°C and 30°C. The temperature of the selected block shall be considered as representative of the average temperature of the battery. It is desirable that the average cell surface temperature and the ambient temperature fall as nearer to the reference temperature of 20°C or 25°C as possible.

In case of batteries having a capacity lower than 80% of the nominal rating it is advisable to replace them within 12 months

Here below some precaution to be taken:

- Discharge must be stopped at the final discharge voltage.
- Deeper discharges must not be carried out unless specifically agreed with FIAMM.
- Recharge immediately the battery after each (full or partial) discharge test.

◆ Service/Functional test

This is a test of the battery's ability, to satisfy the design requirements of the system. It means to discharge the battery directly to the load (in this case take precautions to ensure that a battery failure does not jeopardise other equipment) or dummy load to simulate a main failure.

1. Record the floating voltage of each cell, as well as the total system voltage
2. Check the actual load (A or W), as well as the minimum admissible voltage of the system
3. On FIAMM discharge tables you can approx. determinate the discharge rate (minutes of discharge)
Please note that battery performances change (decrease) with battery age. After switching off the rectifier, discharge the battery for a time of 20% of that calculated discharge rate
4. During the discharge, record at regular intervals, cell/block voltage, battery temperature, discharge current, total battery voltage
5. For safety reason, during the test assure that the total battery voltage remains above the minimum depending on discharging rate in order to avoid any failure to the system (please note that approaching to the final voltage, the voltage curve decreases rapidly)
6. For particular comments on test's data, please refer to FIAMM technical offices

◆ Capacity test

Please carry out this test only when complete information on the quantity of energy inside the battery is requested. **Take precautions because after this test battery SHOULD NOT BE ABLE TO SUPPLY ENERGY IN CASE OF MAIN FAILURE.**

Dummy load is usually necessary to provide the request discharge current. Test is usually carried out to verify the battery capacity to a specify end voltage and discharge rate (usually 1, 3 or 10 hours).

Test must be conducted in accordance with EN 60896-21/22. Please refer to prescription indicated in the above standard. Record at regular intervals every half an hour at the beginning, every 10 minutes the last half an hour cell/bloc voltage, battery temperature on pilot cell, discharge current, total battery voltage (in any case voltage reading has to be made at least at 25%, 50% and 80% of the discharge time).

According IEC60896-21 the discharge shall be terminated when one of the following values t_{disch} , whichever comes first, has been recorded:

1. t_{disch} = the elapsed time of discharge of the string, with n cells, to a voltage of $n \times U_{final}$ (V)
2. t_{disch} = the elapsed time when the first of the unit in the string reached a voltage of

$$U = U_{final} - \left(\sqrt{\frac{\text{unit voltage}}{2}} \right) \times 0.2$$

At the end of discharging test, batteries have to be recharged immediately.

The following formula determinates the battery capacity:

$$C = \text{discharge current} \times t_{disch}$$

(where t_{disch} is indicated in hours)

For temperatures different from the nominal (20°C) and discharge rates between 3 to 10 hours, the battery capacity shall be corrected as follows:

$$C_{20^{\circ}\text{C}} = \frac{C}{1 + \lambda(\theta - 20)}$$

Where:
 θ = initial pilot cell temperature (°C)
 $\lambda = 0.006$ for tests > 1 hour
 $\lambda = 0.01$ for tests \leq 1 hour

Trending battery capacity during years will provide information in predicting when the battery will no longer meet design requirements.

❖ UNPACKING

◆ Inspection

Upon receiving a shipment, of battery cells, it is advisable to open the shipping containers and carefully check the cells and hardware against the packing list. The contents of each consignment are carefully inspected by FIAMM before shipment. Any damage must be reported immediately to the carrier and the damaged items retained for inspection by the carrier's representative.

◆ Handling

Monolite units are shipped fully charged and must be treated with care at all times. The product is capable of supplying high short circuit currents, even if the case or lid are damaged. Always lift the individual unit from underneath, or by the build-in-lifting handles. Never apply force to, or drop anything on, the terminal posts: doing so may damage the threads or the post seals.

❖ STORAGE

◆ Storage prior to installation

VRLA batteries range are delivered activated/filled and charged ready for installation. If they cannot be installed immediately, the following instructions need to be respected.

◆ Storage Conditions

A good storage practice requires as follows:

- Battery storage area has to be clean, cool and dry.
- Surroundings have to be kept clean.
- Elevated temperatures, direct and indirect sunshine have to be avoided.
- Optimum storage temperature rang is -10°C to +30°C.
- Avoid storage in ambient with a relative humidity greater than 90%.
- Battery cells must be protected from harsh weather, moisture and flooding.
- Storage on a pallet wrapped in plastic material is permitted, in principle. However, it is not recommended in rooms where temperature fluctuates significantly, or if high relative humidity can cause condensation under the plastic cover.
- With time, this condensation can cause a whitish hydration on the poles and lead to high self-discharge by leakage current.
- Atmospheres with chemical contaminants have to avoid.
- Do not load other merchandise on top of unprotected batteries.
- Battery cells must be protected from dropping objects, from falling down and falling over.
- Battery cells must be protected from short-circuits by metallic parts or conductive contaminations.

- Avoid storing of unpacked battery cells on sharp-edged supports.
- Stacking of pallets is not permitted unless otherwise specified.
- It is recommended to realize the same storage conditions within a batch, pallet or room.

◆ Storage time / Temperature

- VRLA battery ranges have a shelf life of **6 months** at a storage temperature of 20°C.
- The temperature has an impact on the self-discharge rate of battery cells.
- Higher temperatures increase the rate of self discharge and therefore storage life is reduced.
- FIAMM AGM batteries have a self discharge rate of ≤ 2% per month at 20°C and therefore are stored for prolonged periods of time.
- **MAXIMUM** storage period before refresh at the given average storage ambient temperature is as follows :

6 months at 20°C
4 months at 30°C
2 months at 40°C

◆ Storage / Recharge

- As during storage batteries will lose part of their capacity due to self discharge (≤ 2% per month at 20°C), a refreshing charge must be given :
 - 1) when **MAXIMUM STORAGE TIME** is reached

OR

 - 2) when the OCV (open circuit voltage) approaches 2,11Volts/cell

whichever occurs first.

Recharge the cells as directed in FIAMM'S instruction table for AGM battery type. (Usually at 2.4 volt per cell for a period of 24 hours at 20°C).

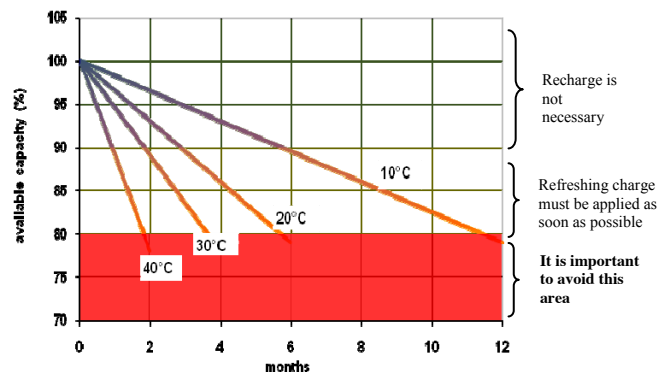

Fig. 6 Storage time versus temperatures.

❖ **VENTILATION (in accordance with EN 50272-2)**

During normal operating conditions, lead acid batteries emits low quantity of gases which can reach an explosive mixture when hydrogen concentration is higher than Lower Explosion Limit (LEL) threshold which is 4%vol. The purpose of ventilating a battery location or enclosure by natural or forced (artificial) ventilation is to maintain the hydrogen concentration below the above stated limit. Battery locations and enclosures are to be considered as safe from explosions, when the concentration of hydrogen is kept below this safe limit.

The minimum air flow rate for ventilation of a battery location or compartment shall be in accordance with European Standard EN 50272 calculated by the following formula:

$$Q = 0,05 \times N \times I_{gas} \times C_{rt} \times 10^{-3}$$

where:

Q = ventilation air flow in m³/h

N = number of cells (each 2 Volt)

C_{rt} = capacity C₁₀ [Ah] at 1.80 volt/cell. at 20°C.

The current I_{gas} [mA/Ah] producing gas as indicated in the table of the above mentioned standard can be assumed as:

I_{gas} = 1 For batteries on float

I_{gas} = 5 For batteries on boost charge

◆ **Determination of openings**

The amount of ventilation air flow shall preferably be ensured by natural ventilation, otherwise by forced (artificial) ventilation. Battery rooms or enclosures require an air inlet and an air outlet with a minimum free area of opening calculated by the following formula:

$$A = 28 \times Q$$

with Q = ventilation flow rate of fresh air [m³/h]
 A = free area of opening in air inlet and outlet [cm²]

Note: For the purpose of this calculation the air velocity is assumed to be 0,1 m/s.

The air inlet and outlet shall be located at the best possible location to create best conditions for exchange of air, i.e.

- openings on opposite walls,
- minimum separation distance of 2 m when openings on the same wall.

The following picture gives an indication of the correct opening to assure a complete battery room air exchange

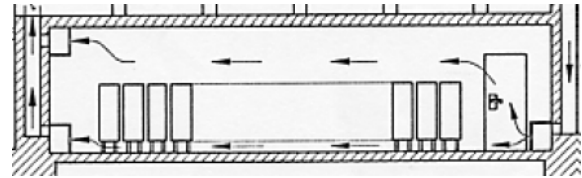

◆ **Forced ventilation**

Where an adequate air flow Q cannot be obtained by natural ventilation and forced ventilation is applied, the charger shall be interlocked with the ventilation system or an alarm shall be actuated to secure the required air flow for the mode of charging selected. The air extracted from the battery room shall be exhausted to the atmosphere outside the building.

◆ **Close vicinity to the battery**

In the close vicinity of the battery the dilution of explosive gases is not always secured. Therefore a safety distance extending through air must be observed within which sparking or glowing devices (max. surface temperature 300 °C) are prohibited. The dispersion of explosive gas depends on the gas release rate and the ventilation close to the source of release. For calculation of the safety distance d from the source of release the following formula applies assuming a hemispherical dispersal of gas. The safety distance “d” is given from the following formula:

$$d = 28,8 \times \sqrt[3]{N} \times \sqrt[3]{I_{gas}} \times \sqrt[3]{C_{rt}}$$

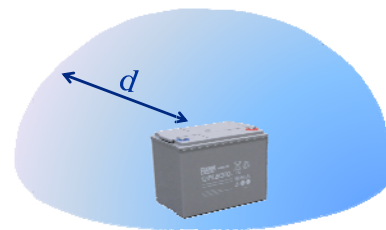

where N depends on the number of cells per monoblock battery (N) or vents openings per cell involved (1/N).

For further information please refer to EN50272 Standard or contact FIAMM at: infostandby@fiamm.com

Note: A calculation program is available on request.

FIAMM

Industrial Batteries

SALES OFFICES

EUROPE

FIAMM S.p.A.
Viale Europa, 63
Montecchio Maggiore 36075 (VI)
ITALY
Tel +39 0444 709311
Fax +39 0444 694178
info.standby@fiamm.com

NORTH AMERICA

FIAMM Energy, LLC
Battery Division
1 Fiamm Way
Waynesboro, GA 30830 - USA
Tel +1 (706) 437-3220
Fax +1 (706) 437-3300
info.standby.america@fiamm.com

ASIA PACIFIC

FIAMM ASIA PACIFIC Pte Ltd
24 Jurong Port Road, #02-04
CWT Distripark, SINGAPORE 619097
Tel +65 6867 6152
Fax +65 68626550
info.standby.asia@fiamm.com

MIDDLE EAST & AFRICA

FIAMM S.p.A.
Viale Europa, 63
Montecchio Maggiore 36075 (VI)
ITALY
Tel +39 0444 709311
Fax +39 0444 694178
info.standby@fiamm.com

LATIN AMERICA

FIAMM Latin America Ltda.
Av. Piraporinha, 121
CEP 09891-0000
São Bernardo do Campo - SP - Brasil
Tel +55 11 3737 6137
Fax +55 11 3737 6116
baterias.industriais@fiamm.com

CHINA

FIAMM ENERTECH CO., LTD
Hannan Road 458, Shamao Town
Hannan District
Wuhan City, Hubei Province, P.R. CHINA
P.C.430090
Tel +86 27 84782000
Fax +86 27 84782888
info.standby.asia@fiamm.com