



**HIGH
RATE
MAX^{XT}**



UPS12-400MRX

Valve Regulated Lead Acid Battery

Designed for UPS Standby Power Applications.

FEATURES & BENEFITS

APPLICATIONS

- Data Centers
- Network Operations Centers
- Industrial Process Control Facilities
- Internet Housing Sites
- Semiconductor Manufacturing
- Banks & Financial Markets
- Power Generation Plants
- Hospitals & Testing Laboratories
- Emergency 911 Response Centers

- 10 year design life @ 25°C
- Absorbent Glass Mat (AGM) technology for efficient gas recombination of up to 99% and freedom from electrolyte maintenance.
- 3 Year Warranty (refer Dynasty warranty card, 41-9027)
- Patented Long Life Alloy having the lowest calcium levels in the industry - minimizing grid growth, reducing gassing, and extending battery life.
- Patented UL Recognized Flame-arresting vents in each cell for safety and long life.
- Designed with the same recombination, thermal runaway prevention, gassing and flame retardant characteristics of the Bell-core 4228 compliant Dynasty Telecom products.
- Flame retardant polypropylene case and cover compliant with UL94V-2
- Proprietary Fixed Orifice Plate Pasting technology applying active materials on both sides of the grid for consistent cell-to-cell performance, higher capacity and uniform grid protection.
- Thermally welded case-to-cover bond to eliminate leakage.
- Can be operated in any orientation. Upright, side or end mounting recommended.
- Not restricted for air transport - Complies with IATA/ICAO Special Provisions A67.
- Not restricted for surface transport - Classified as non-hazardous material as related to DOT-CFR Title 49 parts 171-189.
- Not restricted for water transport - Classified as non-hazardous material per IMDG Amendment 27.

TECHNICAL DATA

Model	Constant Power Discharge Ratings - Watts per Cell @ 25°C (77°F)										20 hour rate to 1.75 VPC @ 25°C	IEC Rating: 10 hour rate to 1.80 VPC @ 20°C
	Operating Time (in minutes) to 1.67 Volts per Cell											
	5	10	15	20	30	40	45	50	60	90		
UPS12-400MRX	716	517	408	339	261	218	196	183	159	113	109 AH	97 AH

Cells Per Unit	Voltage Per Unit	Weight (Kg)	1 Min Current to 1.75VPC (Amps)	Short Circuit Current (Amps)	Internal Resistance (mOhms)
6	12.98	35.3	572	3059	4.06

SPECIFICATIONS

Operating Temperature Range with temperature compensation	Discharge: -40°F (-40°C) to +160°F (71°C) Charge: -10°F (-23°C) to +140°F (60°C)
Nominal Operating Temperature Range	+74°F (23°C) to +80°F (27°C)
Recommended Maximum Charging Current Limit	C/5 amperes @ 20hr rate
Float Charging Voltage	13.65 ± 0.15 VDC average per 12V unit
Maximum AC Ripple (Charger)	0.5% RMS or 1.5% P-P of float charge voltage recommended for best results. Max voltage allowed = 1.4% RMS (4% P-P) Max current allowed = C/20
Self Discharge	Battery can be stored up to 6 months at 77°F (25°C) before a freshening charge is required. Batteries stored at temperatures greater than 77°F (25°C) will require recharge sooner than batteries stored at lower temperatures. See C&D brochure 41-7272, Self-Discharge and Inventory Control for details.
Equalize charge and cycle service voltage	14.40 to 14.80 VDC average per 12V unit @ 77°F (25°C)
Terminal	Threaded copper alloy insert terminal to accept 1/4-20 UNC bolt.
Terminal Hardware Initial Torque	110 in.-lbs. (12.4 N-m)

DIMENSIONS

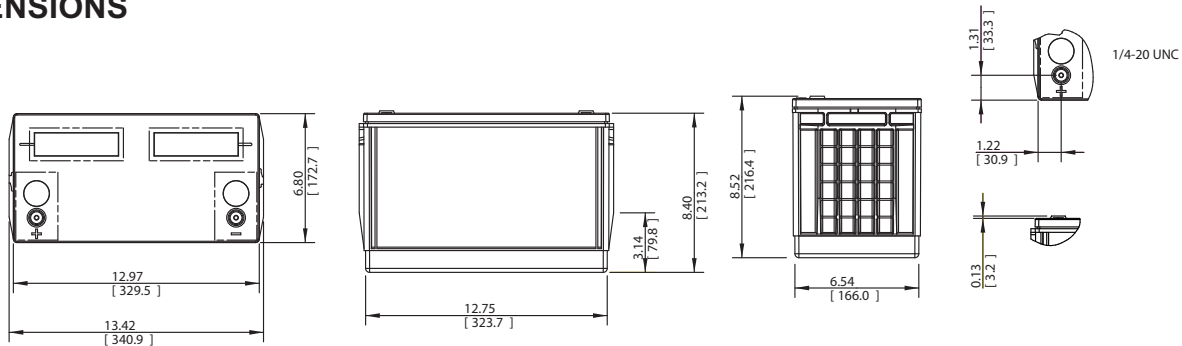

CONSTANT POWER DISCHARGE RATINGS

Constant Power Discharge Ratings - Watts Per Cell @ 20°C (68°F)										
Operating Time To End Voltage (in minutes)										
End Point Volts/Cell	5	10	15	20	30	40	45	50	60	90
1.75	575	454	363	305	239	201	182	172	151	107
1.70	637	473	376	314	244	205	185	174	152	108
1.67	673	486	383	319	247	207	186	175	153	108
1.65	696	491	387	322	250	208	188	176	153	109

Constant Power Discharge Ratings - Watts Per Cell @ 77°F (25°C)										
Operating Time To End Voltage (in minutes)										
End Point Volts/Cell	5	10	15	20	30	40	45	50	60	90
1.75	612	483	386	324	252	212	191	180	157	111
1.70	678	503	400	333	258	215	194	182	158	112
1.67	716	517	408	339	261	218	196	183	159	113
1.65	740	522	412	342	264	219	197	184	160	113

CONSTANT CURRENT DISCHARGE RATINGS

Constant Current Discharge Ratings - Amperes @ 20°C (68°F)									
Operating Time To End Point Voltage (in hours)									
End Point Volts/Cell	1	2	3	5	8	10	12	20	24
1.85	71.9	38.9	27.2	17.3	11.4	9.41	8.00	5.08	4.32
1.80	75.5	40.7	28.4	18.0	11.9	9.76	8.29	5.25	4.46
1.75	76.5	41.3	28.8	18.4	12.1	9.93	8.43	5.33	4.52

Constant Current Discharge Ratings - Amperes @ 77°F (25°C)									
Operating Time To End Point Voltage (in hours)									
End Point Volts/Cell	1	2	3	5	8	10	12	20	24
1.85	74.8	40.4	28.2	17.9	11.8	9.7	8.21	5.21	4.43
1.80	78.7	42.3	29.4	18.6	12.2	10.0	8.51	5.39	4.57
1.75	79.7	42.9	29.8	19.0	12.5	10.2	8.65	5.46	4.64

C&D TECHNOLOGIES, INC.

1400 Union Meeting Road
P.O. Box 3053 • Blue Bell, PA 19422-0858
(215) 619-2700 • Fax (215) 619-7899 • (800) 543-8630
customersvc@cdtechno.com
www.cdtechno.com

Any data, descriptions or specifications presented herein are subject to revision by C&D Technologies, Inc. without notice. While such information is believed to be accurate as indicated herein, C&D Technologies, Inc. makes no warranty and hereby disclaims all warranties, express or implied, with regard to the accuracy or completeness of such information. Further, because the product(s) featured herein may be used under conditions beyond its control, C&D Technologies, Inc. hereby disclaims all warranties, either express or implied, concerning the fitness or suitability of such product(s) for any particular use or in any specific application or arising from any course of dealing or usage of trade. The user is solely responsible for determining the suitability of the product(s) featured herein for user's intended purpose and in user's specific application.